

# BEGTON12 J/S

## PŘISAZENÝ PROFIL SURFACE PROFILE

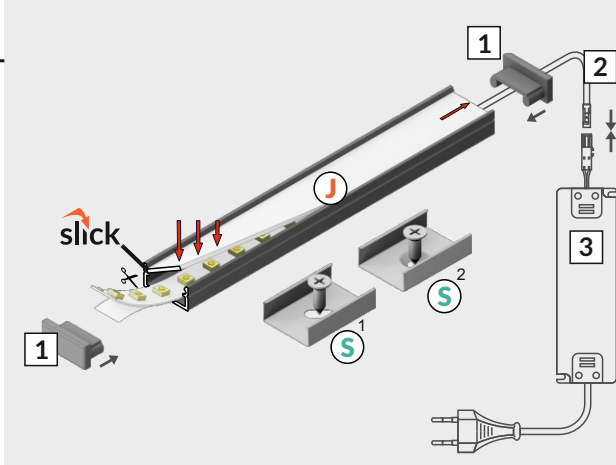

- J** difuzor J slick  
J slick cover
- S**<sup>1</sup> držák S pružný, otvor oválný  
S flexible mounting plate
- S**<sup>2</sup> držák Z pružný, otvor zahluběný  
cone Z flexible mounting plate
- 1** koncovka BEGTON12  
BEGTON12 ending
- 2** napájecí kabel  
power supply cable
- 3** LED napájecí zdroj  
LED power supply

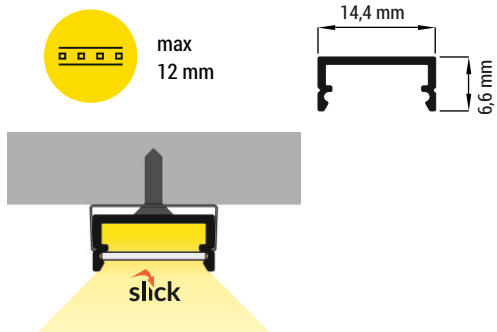

nůžky  
scissors



kleště  
pliers



pájčka  
soldering iron



pájka  
solder



lepidlo  
glue

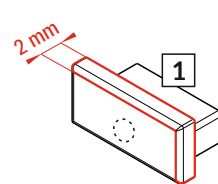
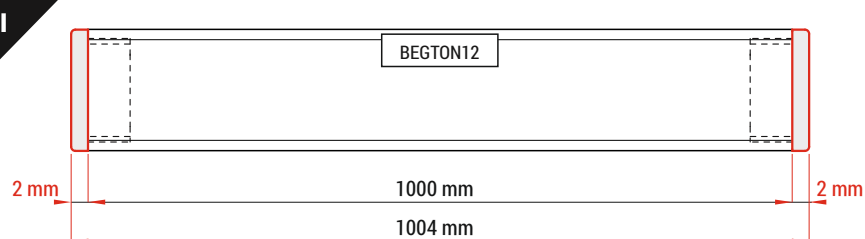

**Pozor!** Koncovka s označenými místy pro vrtání otvorů  
**Note!** Ending with marked space to bore the holes

**Pozor!** S koncovkami se svítidlo prodlouží o 2 mm na každé straně.  
**Note!** Ending thickness increases the length of the luminaire by 2 mm each side.

II

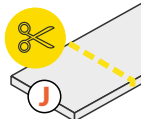

Délka difuzoru se rovná délce profilu.  
The length of the cover is equal to the length of the profile.

III

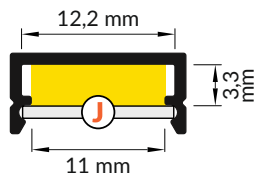
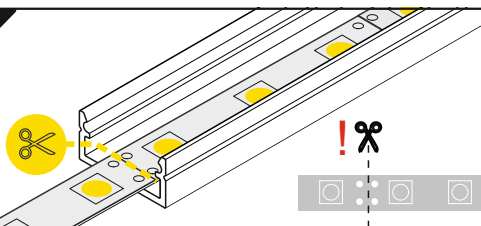

Ověř rozměry prostoru pro LED pásek.  
Dimensions of the space to install LED source.

IV

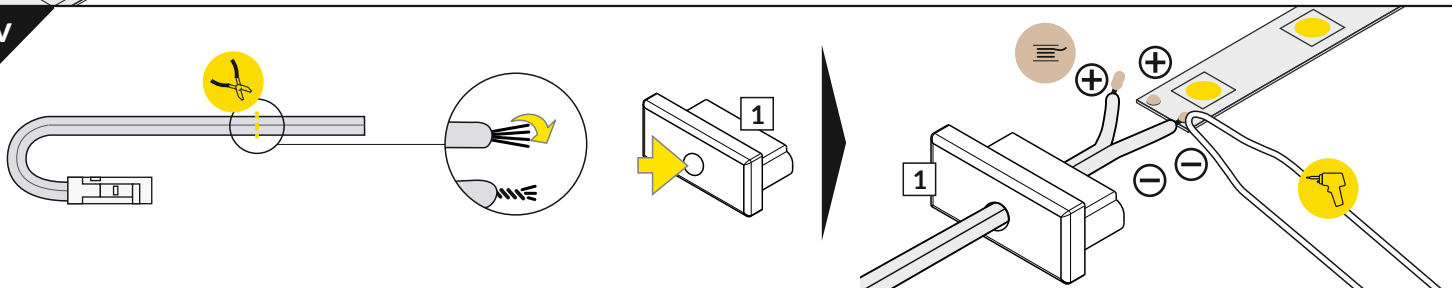

V

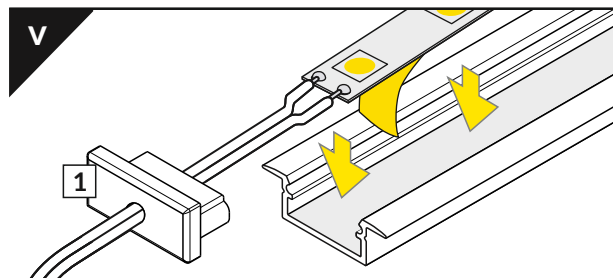

VI

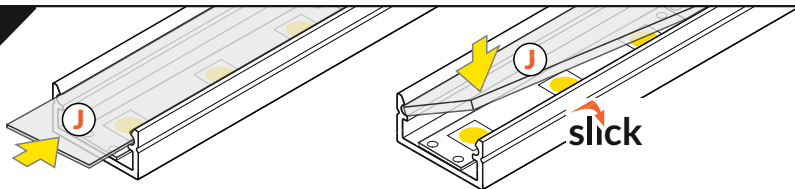

difuzor J slick / J slick cover

VII

## MOUNTING / MONTÁŽ

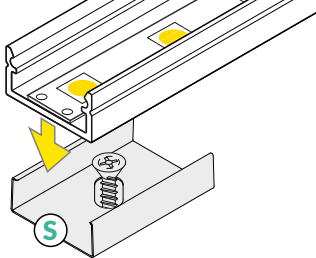

držák S pružný, otvor oválný  
S flexible mounting plate

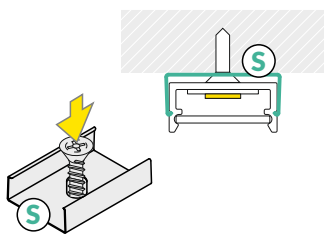

držák S pružný, otvor oválný  
S flexible mounting plate

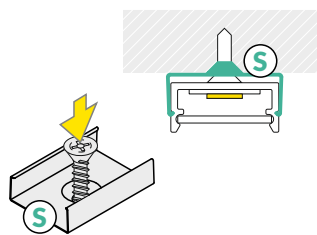

držák Z pružný, otvor zahloubený  
cone Z flexible mounting plate

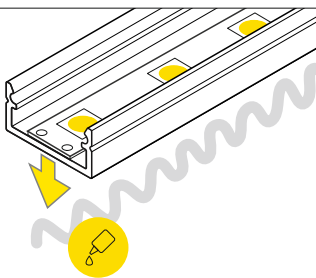

lepidlo  
glue

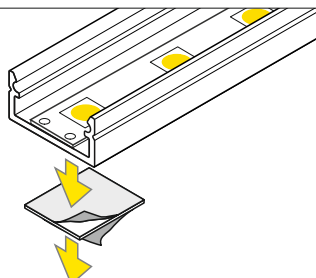

oboustranná lepicí páska 25x25  
two-sided adhesive tape 25x25

VIII

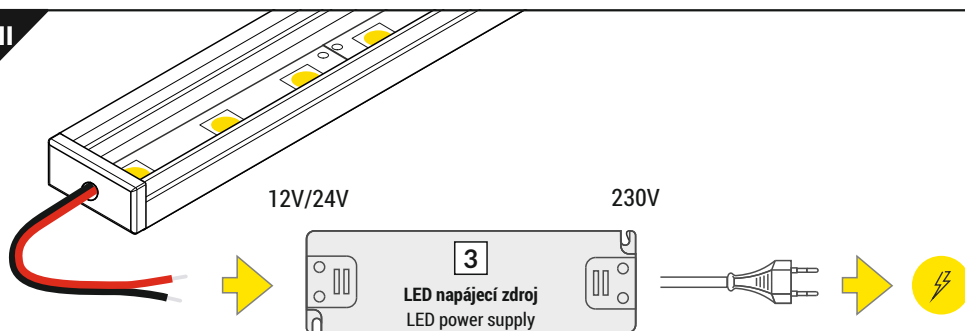

## PŘÍSLUŠENSTVÍ / ACCESSORIES

- spínače
- stmívače + ovladače
- pohybové senzory
- power switches
- controller + remote
- movement sensors

Zjistí více - [www.tron.cz](http://www.tron.cz) - TRON katalog LED profilů

Check the rest - [www.tron.cz](http://www.tron.cz) - TRON LED profiles catalogue