

BACK10 A/UX

DVA SVĚTELNÉ SMĚRY

TWO LIGHTING DIRECTIONS

- dekorativní a osvětlovací profil
- T struktura profilu umožňuje směřování světla do čtyř směrů (nahoru, dolů, doleva, doprava)
- montáž pomocí dvou speciálních typů držáků (do zdi) nebo přímo do nábytku pomocí vrtů
- variantní použití difuzoru A
- LED pásek: šířka max. 10mm, příkon max. 18W/m
- decorative and lighting profile
- the T-shaped structure makes it possible to direct the light beam in two directions (up/down, left/right)
- mounting with two special holders (to the wall) or directly to a piece of furniture, using screws
- optionally, the A cover can be used
- LED strip: width max. 10mm, power supply max. 18W/m

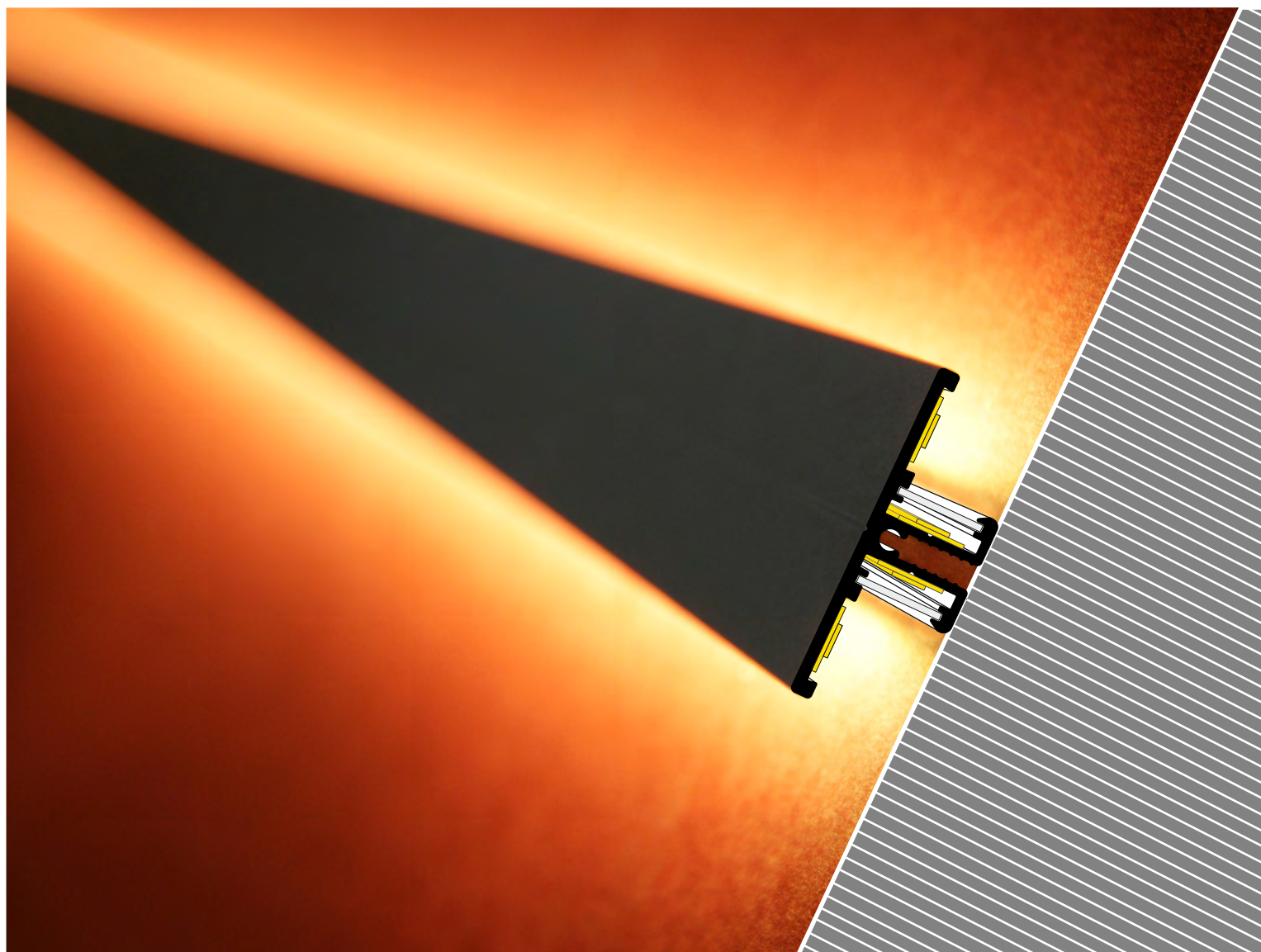

PODOBNE PROFILY / SIMILAR IN THE OFFER



TWIN8



AMBI12
C



WALLE12
CD



- A** difuzor **A** nasouvací
A slide cover
- U**¹ držák **U** pružný, otvor oválný
U flexible mounting plate
- U**² držák **U** pružný, otvor zahloubený
cone U flexible mounting plate
- X**¹ držák **X** hliníkový, otvor kulatý
X mounting plate

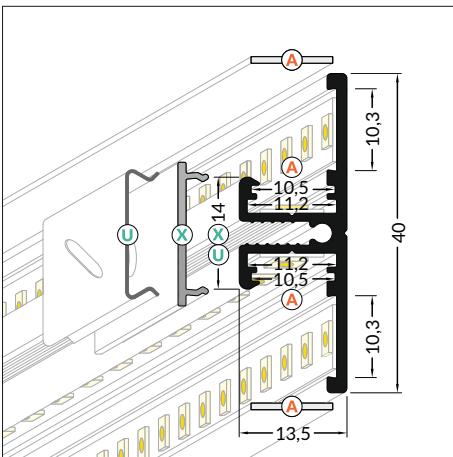
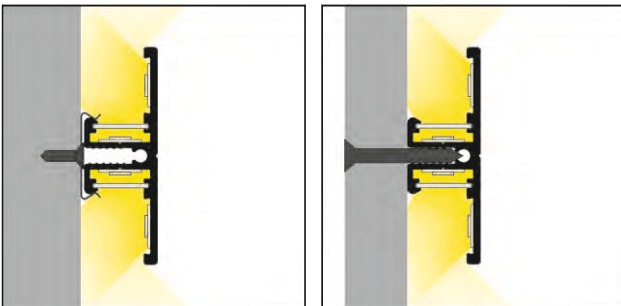
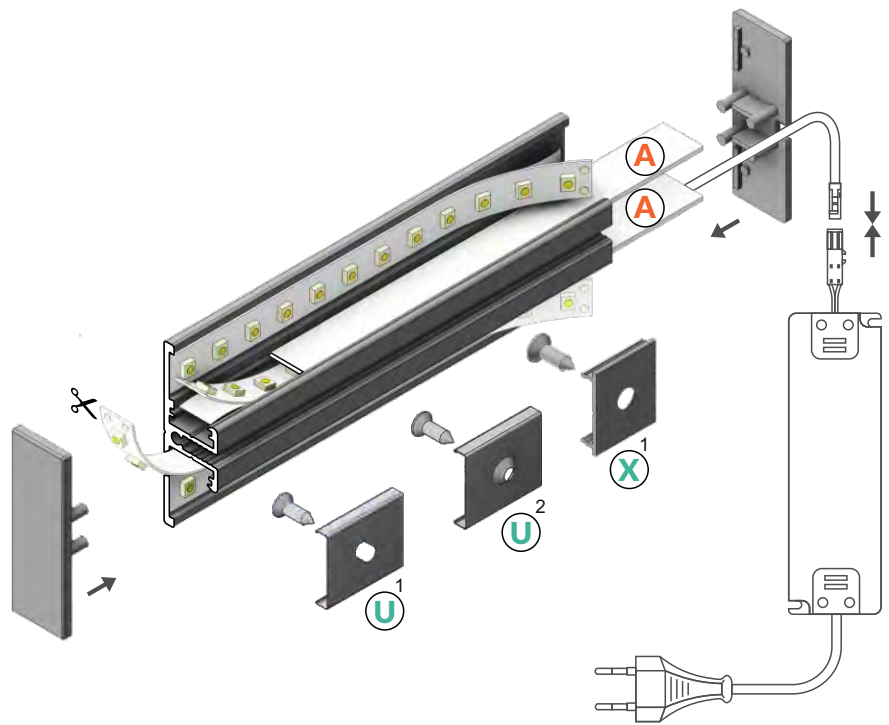

 max. 10 mm

 speciální
special application



délka = 2 m
balení = 10 x 2 m
length = 2 m
package = 10 x 2 m

 bílý lak
white painted
00209852

 stříbrný elox
anodized
00209862

 černý elox
black anodized
00209854

 hliník surový
raw aluminium
00209864

Dostupné délky / Available lengths
max. 4m



DIFUZORY / COVERS

difuzor A nasouvací
propustnost: čirý, matný, opálový
materiál: PC, PP

A slide cover
colours: transparent, frosted, white
material: PC, PP

Pozor! Ověř rozměry prostoru pro LED pásek
Note! Dimensions of the space to install LED source

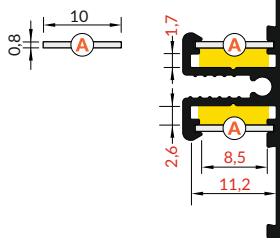

délka = 2 m
balení = 10 x 2 m
length = 2 m
package = 10 x 2 m

A čirý / A transparent
00209501

A matný / A frosted
00209502

A opálový / A white
00209503

KONCOVKY / ENDINGS

koncovka BACK10
barvy: bílá, stříbrná, černá, šedá
materiál: ABS
BACK10 ending
colours: white, silver, black, grey
material: ABS

koncovka BACK10 s otvorem
barvy: bílá, stříbrná, černá, šedá
materiál: ABS
BACK10 ending with hole
colours: white, silver, black, grey
material: ABS

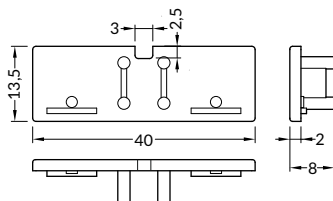
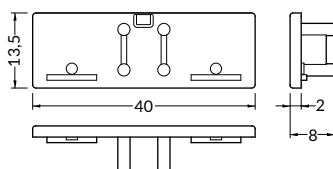

1 pár = 2 ks
balení = 10 párů
1 pair = 2 pcs
package = 10 pairs

bílá
white

s otvorem | **bez otvoru**
with hole | without hole
00209629 | 00209627

stříbrná
silver

s otvorem | **bez otvoru**
with hole | without hole
00209631 | 00209633

černá
black

s otvorem | **bez otvoru**
with hole | without hole
00209630 | 00209628

šedá
grey

s otvorem | **bez otvoru**
with hole | without hole
00209632 | 00209634

DRŽÁKY / MOUNTINGS

držák U pružný, otvor oválný
barva: nerez
materiál: nerezová ocel
U flexible mounting plate
colour: inox
material: stainless steel

držák U pružný, otvor zahloubený
barva: nerez
materiál: nerezová ocel
cone U flexible mounting plate
colour: inox
material: stainless steel

držák X hliníkový, otvor kulatý
barva: hliník surový
materiál: hliník
X mounting plate
colour: raw aluminium
material: aluminium

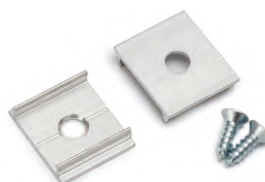
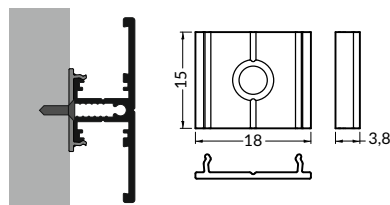
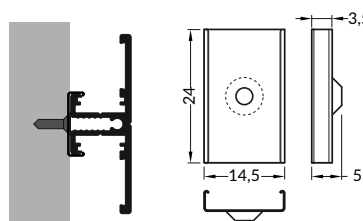
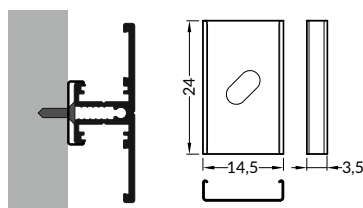

1 pár = 2 ks
balení = 10 párů
1 pair = 2 pcs
package = 10 pairs

držák U pružný, otvor oválný
U flexible mounting plate

nerez | 00209579
inox

držák U pružný, otvor zahloubený
cone U flexible mounting plate

nerez | 00209580
inox

držák X hliníkový, otvor kulatý
X mounting plate

hliník surový
raw aluminium
00209605



SPOJKA / CONNECTOR

spojka **X** montážní
barva: hliník surový
material: hliník

X connector 180 deg
colour: raw aluminium
material: aluminium

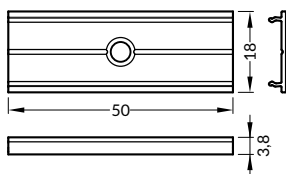

1 sada
1 set



hliník surový
raw aluminium
00210358

