

WALLE12 BCD

LED PROFIL PRO MONTÁŽ NA STĚNU

WALL-MOUNTED PROFILE

- dekorativní a osvětlovací profil
- montuje se přímo na stěnu nebo strop
- 6 druhů difuzorů
- vhodný pro venkovní použití (s difuzorem D a LED páskem chráněným proti vlhkosti)
- LED pásek: šířka max. 12mm, příkon max. 25W/m
- decorative and lighting profile
- mounted directly on a wall or ceiling
- 6 types of matching covers
- possibility of outdoor usage (with D cover and waterproof LED strip)
- LED strip: width max. 12mm, power supply max. 25W/m

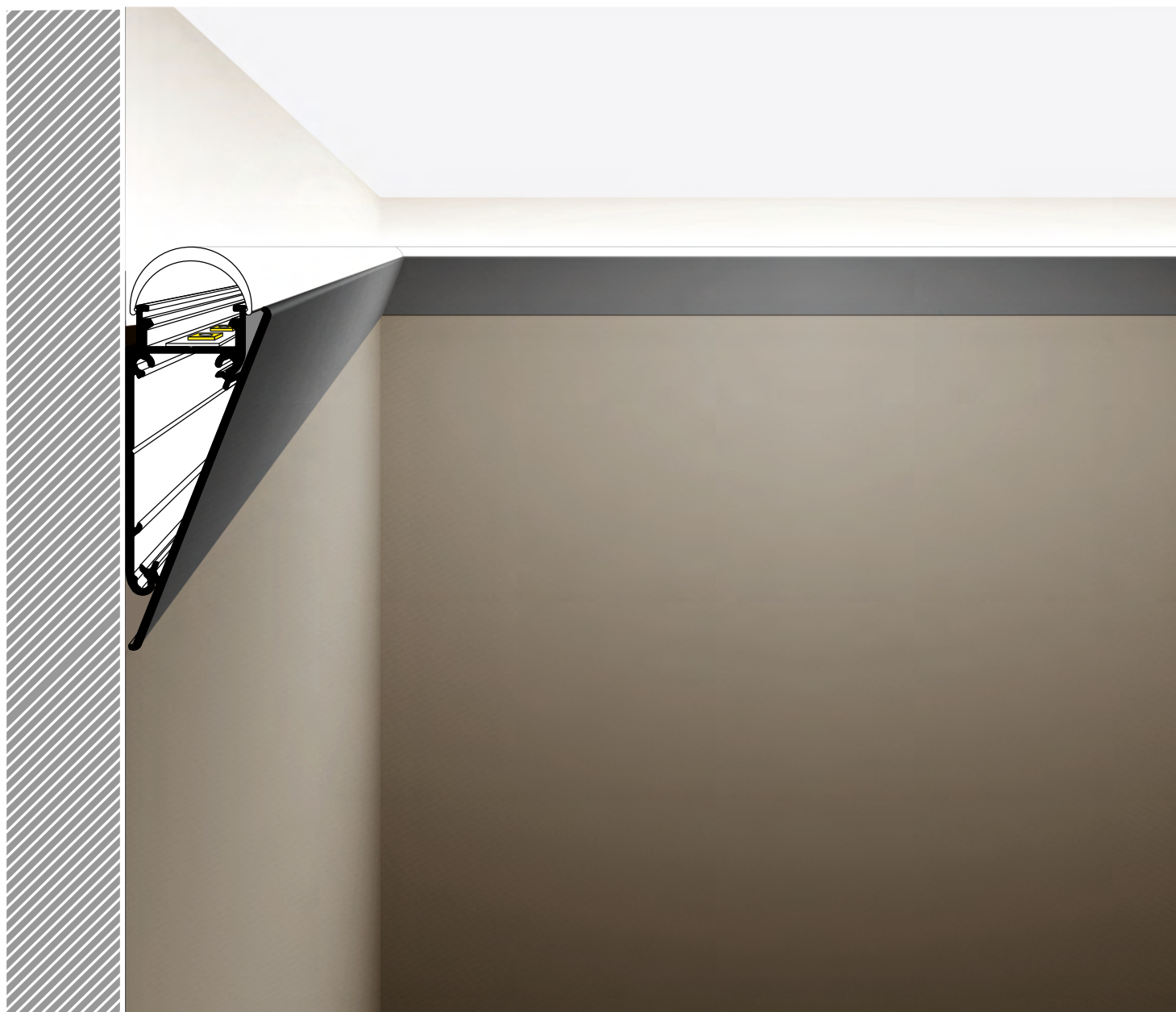

PODOBNE PROFILY / SIMILAR IN THE OFFER

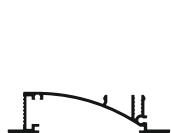

FLAT8
H/UX



BACK10
A/UX



AMBI12
C

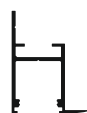

FRAME14
BC/Q



B difuzor B nasouvací
B slide cover

C difuzor C klip
C click cover

D difuzor D klip
D click cover

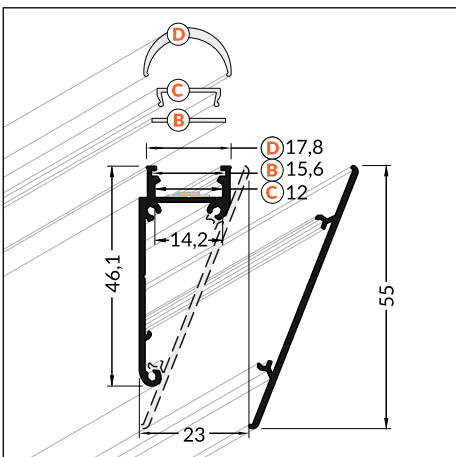
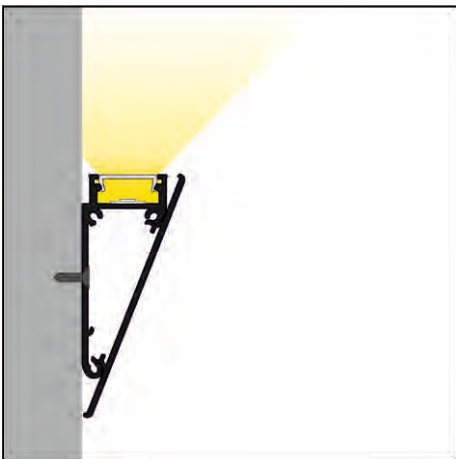
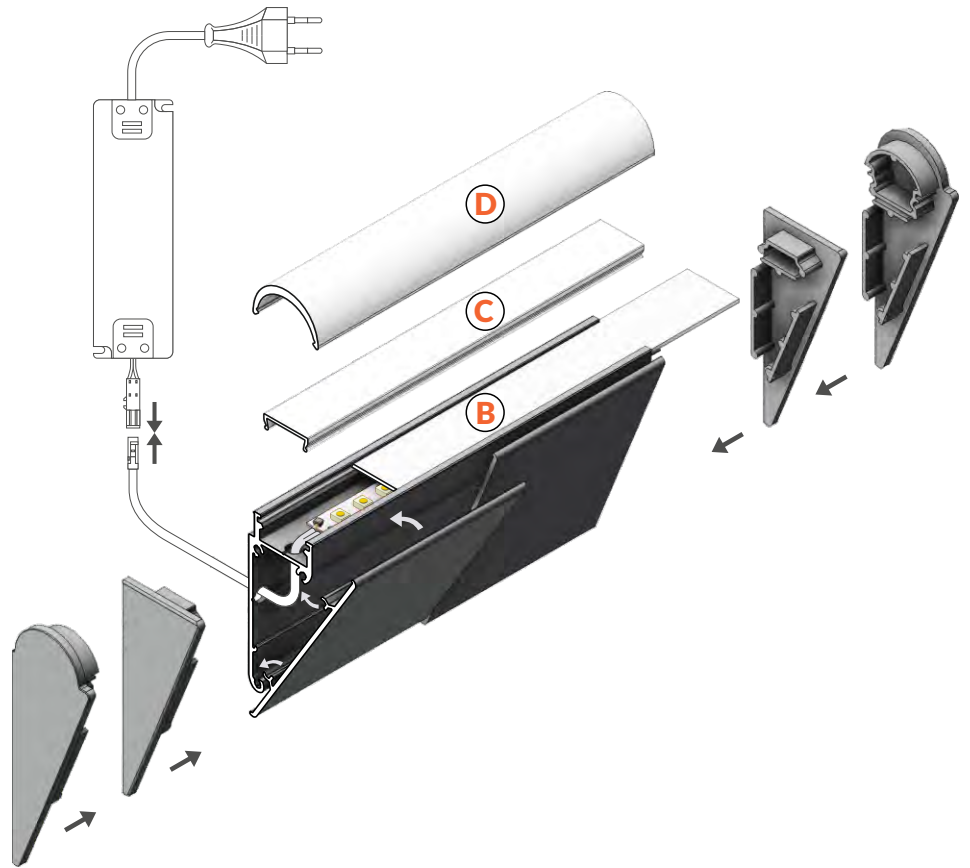

 max. 12 mm

 speciální
special application

délka = 2 m
balení = 10 x 2 m
length = 2 m
package = 10 x 2 m

 bílý lak
white painted
00210204

 stříbrný elox
anodized
00210206

 hliník surový
raw aluminium
00120559

Dostupné délky / Available lengths
max. 4m



DIFUZORY / COVERS

difuzor B nasouvací
propustnost: čirý, matný, opálový
materiál: PC, PP

B slide cover
colours: transparent, frosted, white
material: PC, PP



Pozor!
Ověř rozměry prostoru
pro LED pásek

Note!
Dimensions of the space
to install LED source

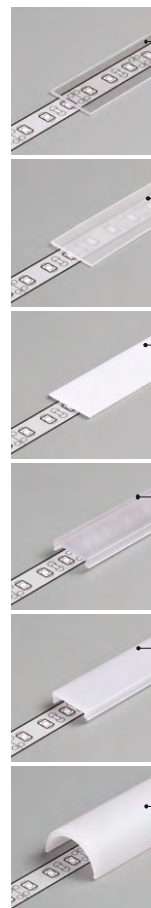
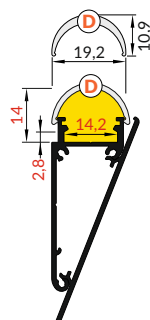
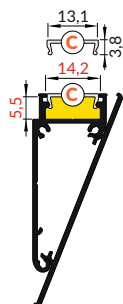
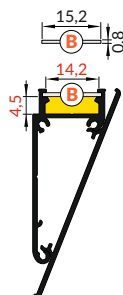

délka = 2 m
balení = 10 x 2 m
length = 2 m
package = 10 x 2 m

B čirý / B transparent
00209510

B matný / B frosted
00209511

B opálový / B white
00209512

C čirý / C transparent
00209513

C opálový / C white
00210532

D opálový / D white
00209522

difuzor C klip
propustnost: čirý, opálový
materiál: PMMA

C click cover
colours: transparent, white
material: PMMA

difuzor D klip
propustnost: opálový
materiál: PMMA

D click cover
colour: white
material: PMMA

KONCOVKY / ENDINGS

koncovka WALLE12
barvy: bílá, stříbrná, šedá
materiál: ABS
WALLE12 ending
colours: white, silver, grey
material: ABS

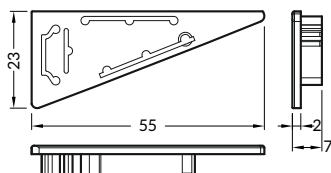

koncovka WALLE12 pro difuzor D
barvy: bílá, stříbrná, šedá
materiál: ABS
WALLE12 D ending
colours: white, silver, grey
material: ABS

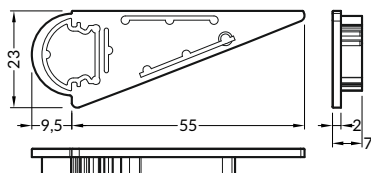

1 pár = 2 ks
balení = 10 párů
1 pair = 2 pcs
package = 10 pairs

koncovka WALLE12
WALLE12 ending

bílá white 00209822
 stříbrná silver 00209823
 šedá grey 00209824

koncovka WALLE12 pro difuzor D
WALLE12 D ending

bílá white 00209825
 stříbrná silver 00209826
 šedá grey 00209827

HLINÍKOVÝ KRYT / ALUMINIUM COVER

kryt profilu WALLE12
barvy: bílý lak, stříbrný elox
materiál: hliník
WALLE12 cover
colours: white, anodized
material: aluminium



délka = 2 m
balení = 10 x 2 m
length = 2 m
package = 10 x 2 m

bílý lak white painted 00210198
 stříbrný elox anodized 00210200



SPOJKY / CONNECTORS

spojka WALLE12 montážní, otvor oválný

barva: nerez

materiál: nerezová ocel

WALLE12 straight connector

colour: inox

material: stainless steel

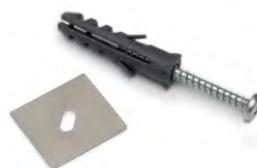
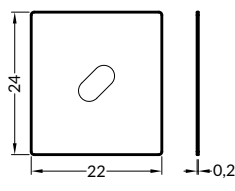

spojka WALLE12, 90° horizontální

barvy: bílý lak, stříbrný elox

materiál: hliník

WALLE12 connector 90 deg

colours: white, anodized

material: aluminium

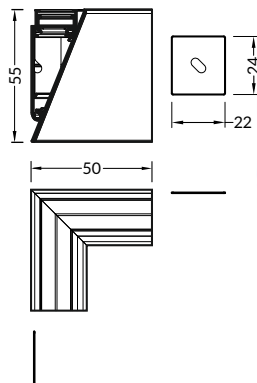

1 sada

1 set



nerez
inox

00210357



bílý lak
white painted
00210355



stříbrný elox
anodized
00210356

