

EDGE10 BC

ZAKONČENÍ HRAN A OSVĚTLENÍ REKLAMNÍCH VITRÍN

FINISHING EDGES AND LIGHTING OF DISPLAY WINDOWS

- pro zakončení a posílení hran výstavních vitrín s tloušťkou menší než 8mm
- vhodné pro dekorativní orámování reklamních výloh
- šikmé osvětlení - netvoří odlesky
- horní nebo spodní osvětlení
- snadná instalace - pro pozorovatele neviditelná oboustranná lepicí páska
- při použití tenčího skla doporučujeme použít přídavné klíny nebo lepicí pásku
- LED pásek: šířka max. 10mm, příkon max. 20W/m
- the product for finishing and strengthening display window edges to a thickness up to 8 mm
- suitable for decorative 'framing' of the display window
- light is emitted at an angle - it does not cause glare
- top or bottom illumination
- easy installation - a double-sided tape not visible to customers
- when using on a thinner glass, consider additional wedging or adhesive tape
- LED strip: width max. 10mm, power supply max. 20W/m



PODOBNE PROFILY / SIMILAR IN THE OFFER



TWIN8



MIKRO10



MIKRO-LINE12

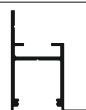

FRAME14
BC/Q



CABI12
E



B difuzor B nasouvací
B slide cover

C difuzor C klip
C click cover

C optika C lineární klip
C lens cover

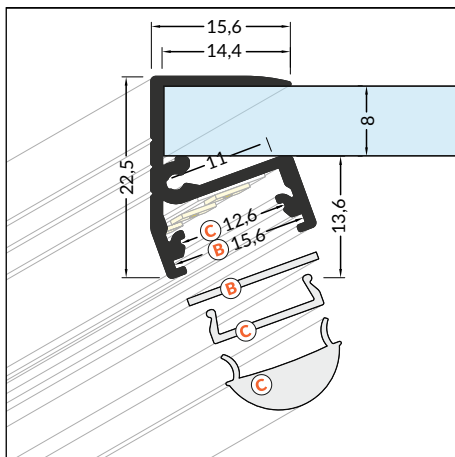
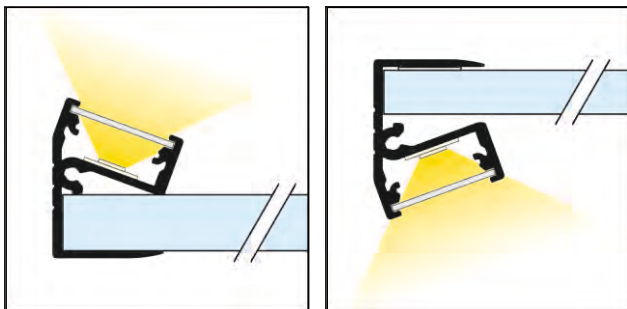
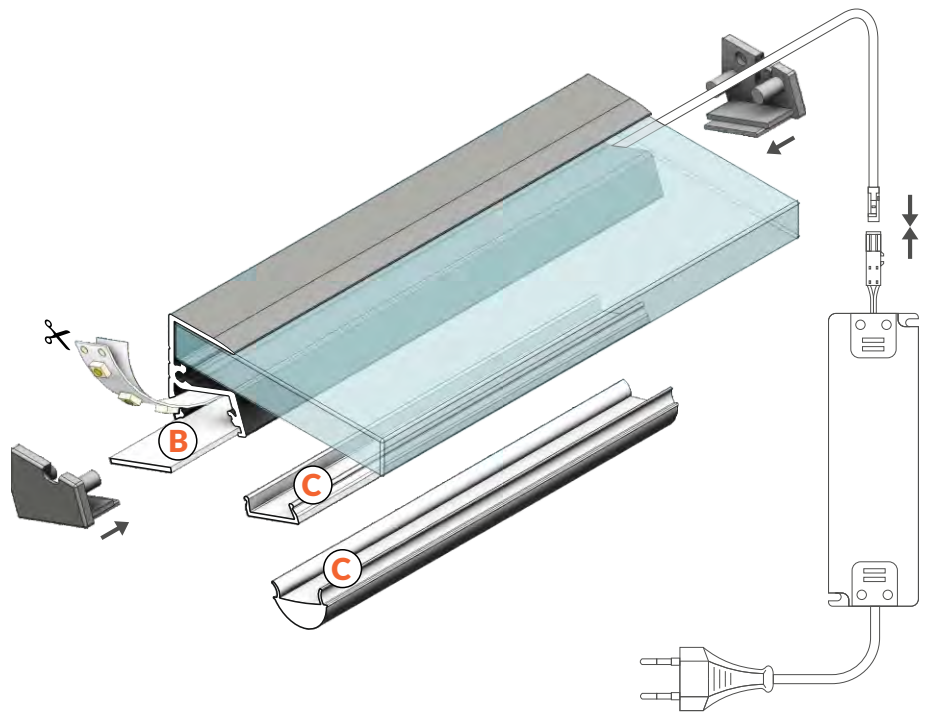



 max. 10 mm

 pro skleněné police
glass application

délka = 2 m
balení = 10 x 2 m
length = 2 m
package = 10 x 2 m

 bílý lak
white painted
00209945

 stříbrný elox
anodized
00209949

 černý elox
black anodized
00209947

 hliník surový
raw aluminium
00209951

Dostupné délky / Available lengths
max. 4m



DIFUZORY / COVERS

difuzor B nasouvací
propustnost: čirý, matný, opálový
materiál: PC, PP

B slide cover
colours: transparent, frosted, white
material: PC, PP



Pozor! Ověř rozměry prostoru pro LED pásek
Note! Dimensions of the space to install LED source

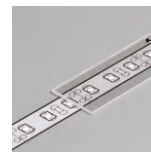
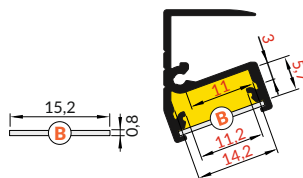

délka = 2 m
balení = 10 x 2 m
length = 2 m
package = 10 x 2 m

B čirý / B transparent
00209510

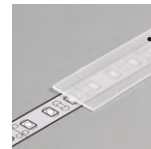

B matný / B frosted
00209511

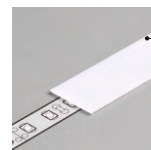

B opálový / B white
00209512

difuzor C klip
propustnost: čirý, opálový
materiál: PMMA

C click cover
colours: transparent, white
material: PMMA

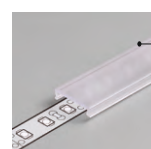
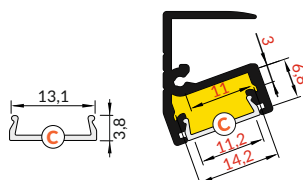

C čirý / C transparent
00209513

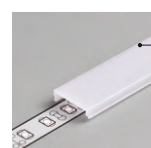

C opálový / C white
00210532

optika C lineární klip
propustnost: čirá
materiál: PC

C lens click cover
colour: transparent
material: PC

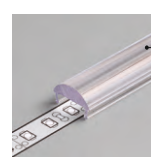
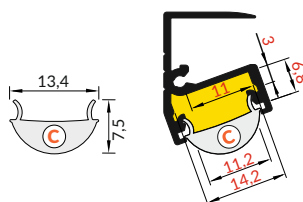

C optika / C lens
00209840

KONCOVKY / ENDINGS

koncovka EDGE10
barvy: bílá, stříbrná, černá, šedá
materiál: ABS

EDGE10 ending with hole
colours: white, silver, black, grey
material: ABS

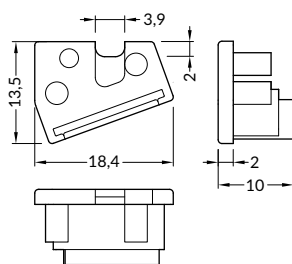

1 pár = 2 ks
balení = 10 párů
1 pair = 2 pcs
package = 10 pairs

-  **bílá** white 00209674
-  **stříbrná** silver 00209673
-  **černá** black 00209675
-  **šedá** grey 00209676

TEPLOVODIVÁ PÁSKA / THERMAL TAPE

teplovodivá páska 45 x 10 mm
lepící, oboustranná

thermal tape 45 x 10 mm
self adhesive, double-sided

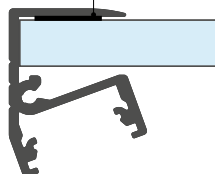

1 ks
1 pc

00209841



V závislosti na způsobu instalace může profil EDGE10 osvětlovat plochu police shora nebo zespodu.

Depending on the installation method, EDGE10 profile may illuminate the display area from the top or from below.

