

# PEN8 |

SPECIÁLNÍ PROFIL / SPECIAL APPLICATION PROFILE



TRON elektronické součástky, s.r.o.

www.tron.cz



max  
8 mm

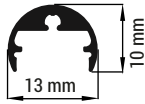

13 mm

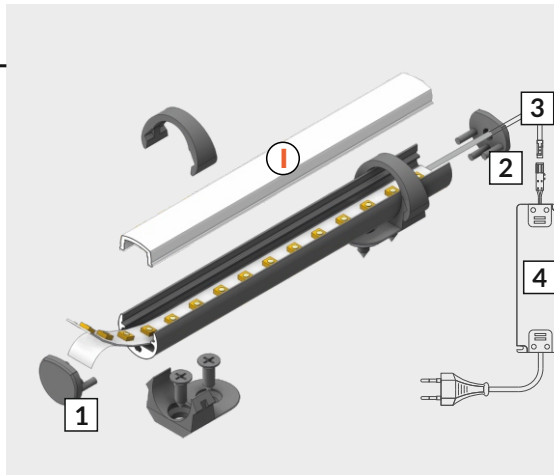
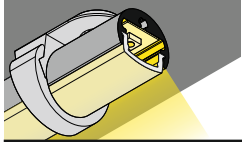

1 difuzor I klip  
I click cover

1 koncovka PEN8  
PEN8 ending

2 koncovka PEN8  
s otvorem  
PEN8  
ending  
with hole

3 napájecí kabel  
power supply  
cable

4 LED napájecí  
zdroj  
LED power  
supply



nůžky  
scissors



kleště  
pliers



pila  
hacksaw



páječka  
soldering iron



pájka  
solder



vrtačka  
drill

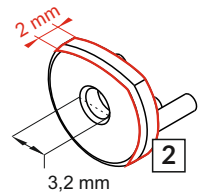
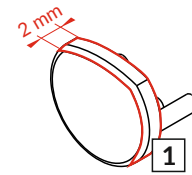
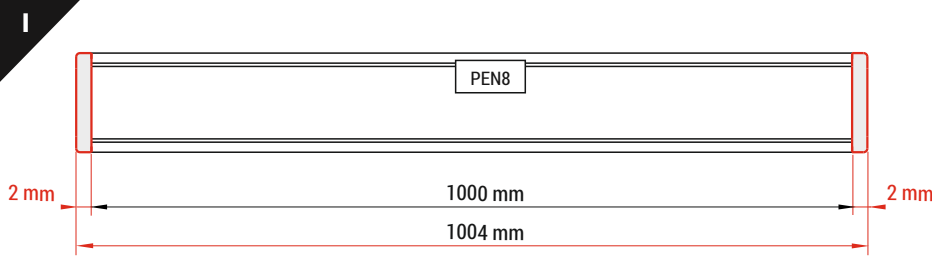

**Pozor!** S koncovkami se svítidlo prodlouží o 2 mm na každé straně.  
**Note!** Ending thickness increases the length of the luminaire by 2 mm each side.

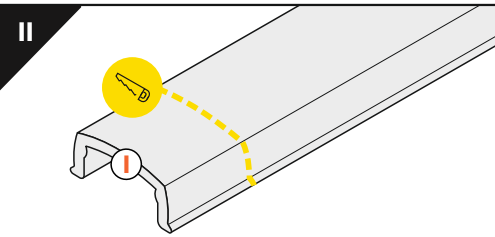

**Délka difuzoru se rovná délce profilu.**  
The length of the cover is equal to the length of the profile.

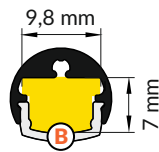
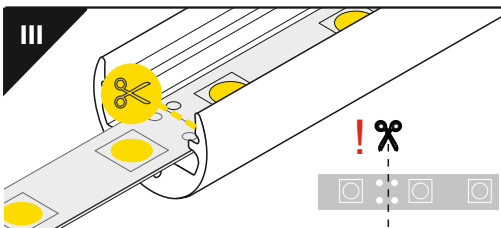

**Ověř rozměry prostoru pro LED pásek.**  
Dimensions of the space to install LED source.

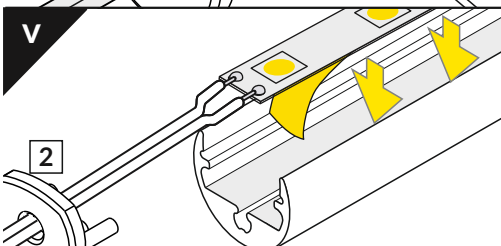
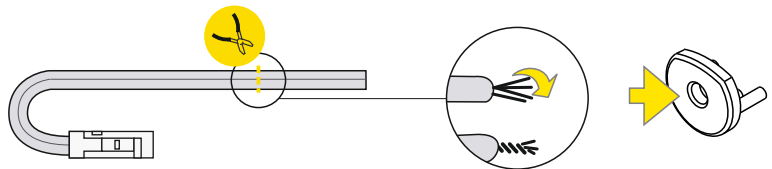
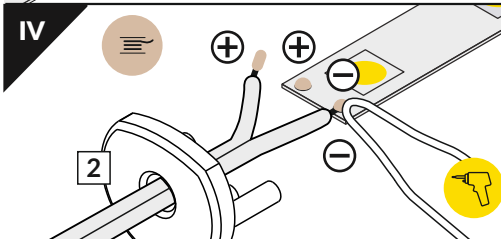

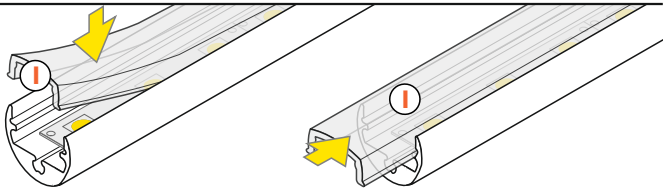

difuzor I klip / I click cover

## VII MONTÁŽ / MOUNTING

|                 |   |
|-----------------|---|
| str. 2 / page 2 | držák PEN8 trojúhelníkový / PEN8 simple holder                      |
| str. 2 / page 2 | držák PEN8 distanční kroužek / PEN8 ring holder                     |
| str. 3 / page 3 | držák PEN8 přisazený / PEN8 flat holder                             |
| str. 3 / page 3 | držák PEN8 koncový rozpěrný / PEN8 stretcher holder                 |
| str. 4 / page 4 | držák PEN8 kloubový se závitem / PEN8 jointed holder with thread    |
| str. 5 / page 5 | držák PEN8 kloubový na hmoždinky / PEN8 jointed holder with ceiling |
| str. 6 / page 6 | držák PEN8 dvojitý se závitem / PEN8 double holder with thread      |
| str. 7 / page 7 | držák PEN8 dvojitý na hmoždinky / PEN8 double holder with ceilings  |
| str. 8 / page 8 | držák PEN8 koncový jednostranný / PEN8 end holder                   |

### držák PEN8 trojúhelníkový / PEN8 simple holder

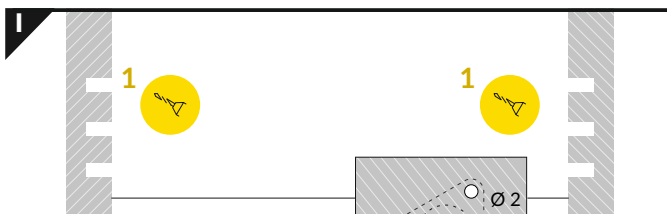

**Pozor!** Pokud držák připevňujete na měkký materiál, pouze označte místa pro vruty, není nutné vyvrtat otvory.

**Note!** Don't need to drill if you are mounting on a soft material. Just mark the spots for the screws.

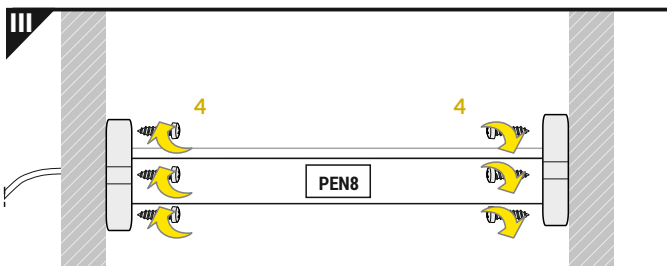
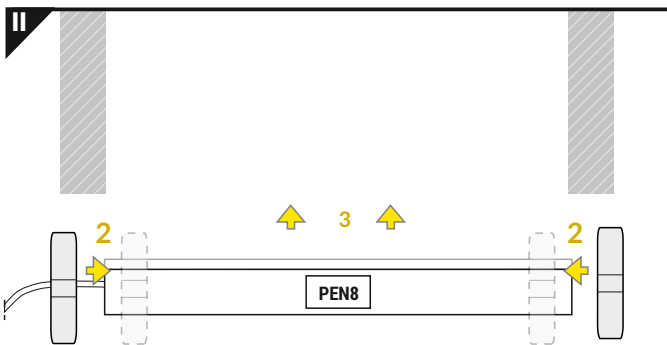

### držák PEN8 distanční kroužek / PEN8 ring holder

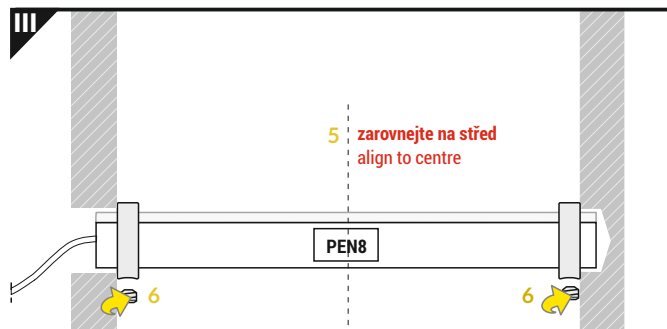
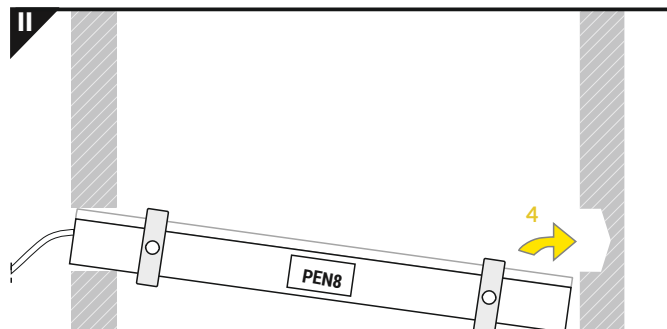
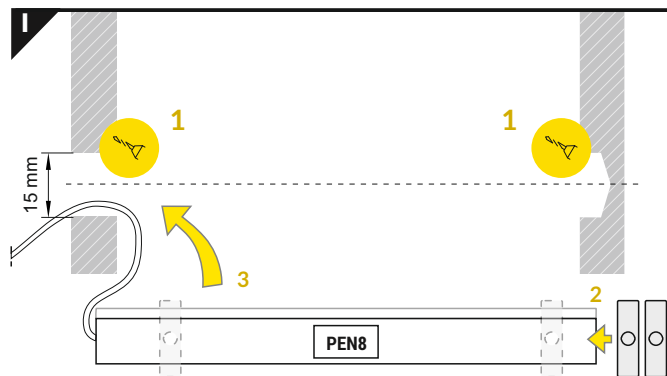

**držák PEN8 přisazený / PEN8 flat holder**

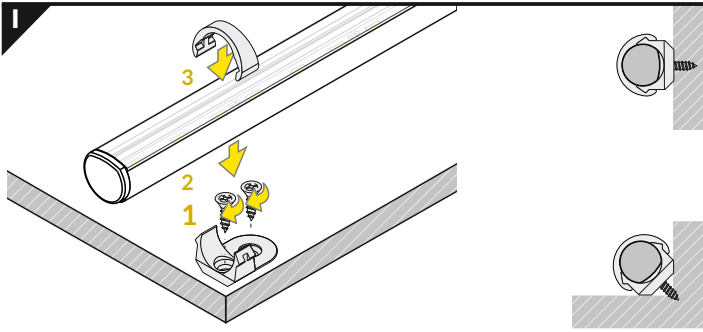

**držák PEN8 koncový rozpěrný / PEN8 stretcher holder**

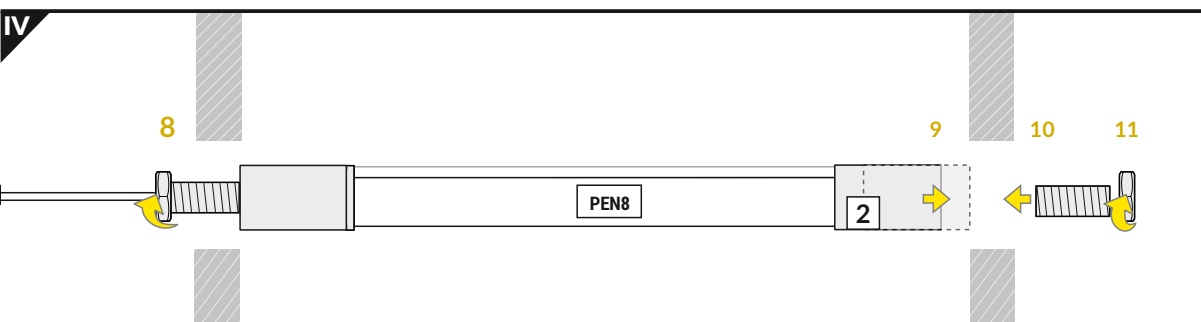
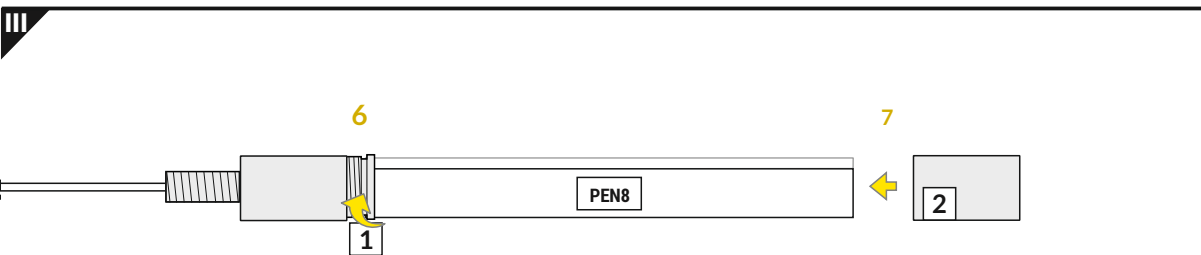
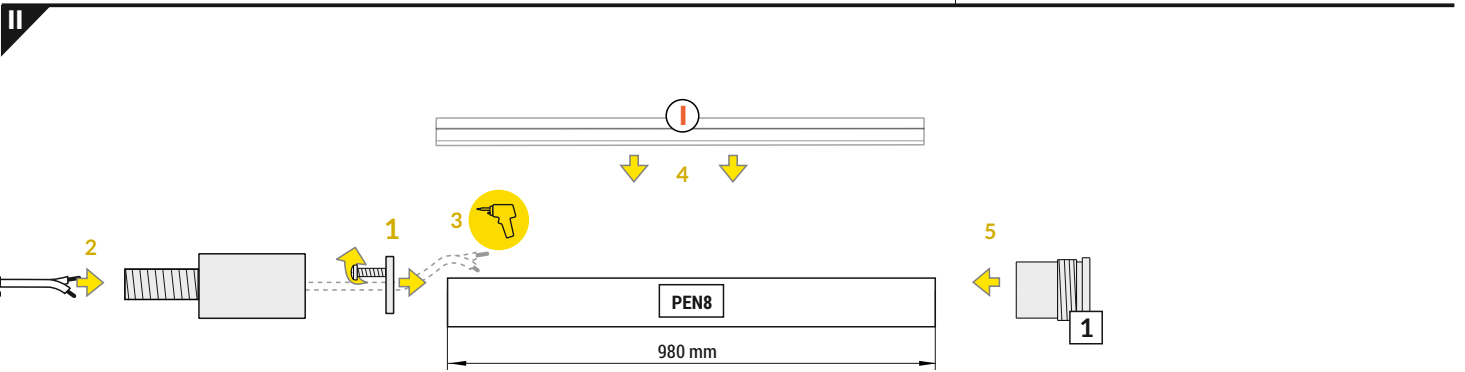
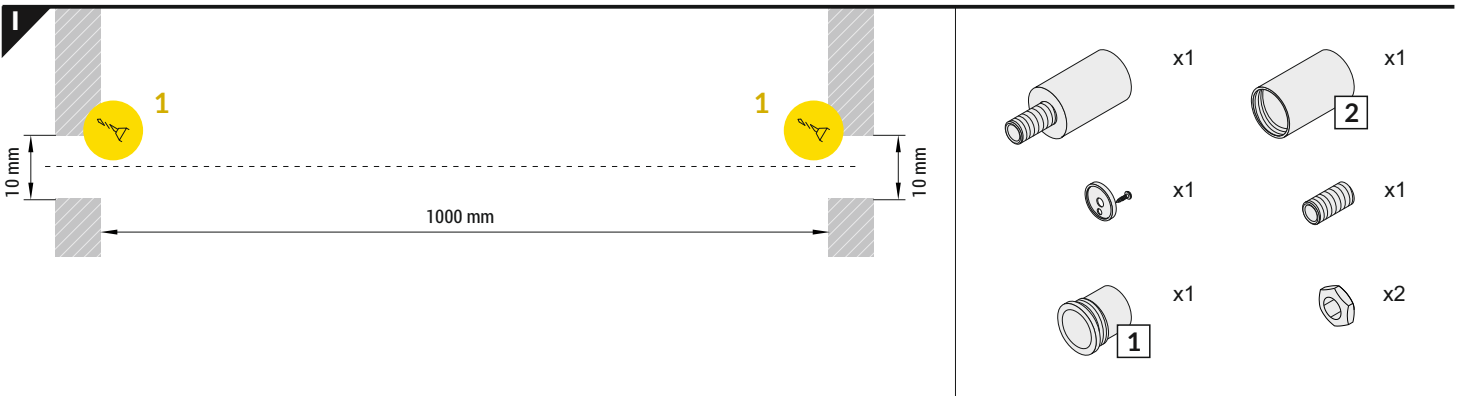

držák PEN8 kloubový se závitem / PEN8 jointed holder with thread

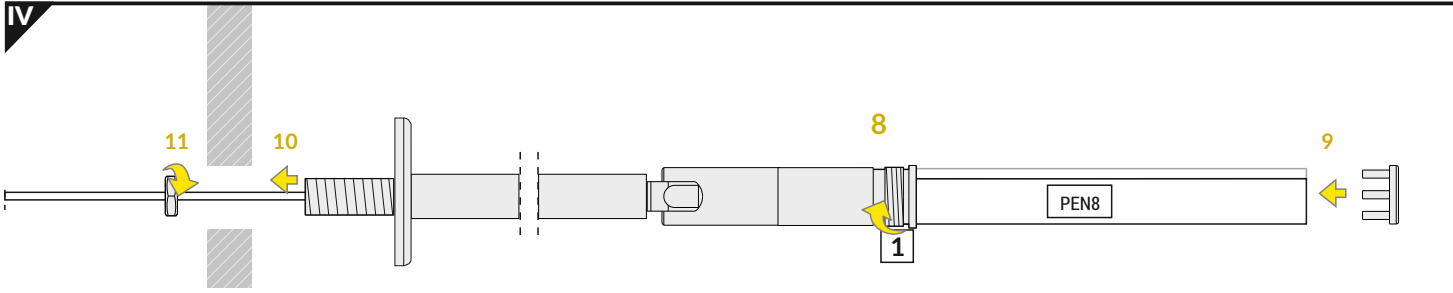
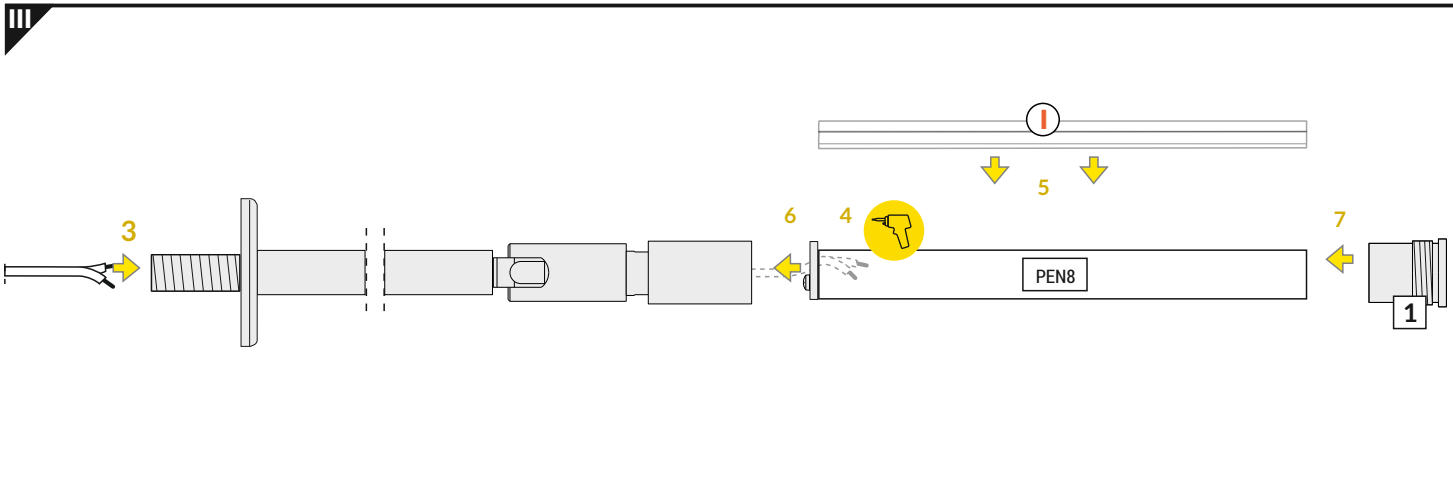
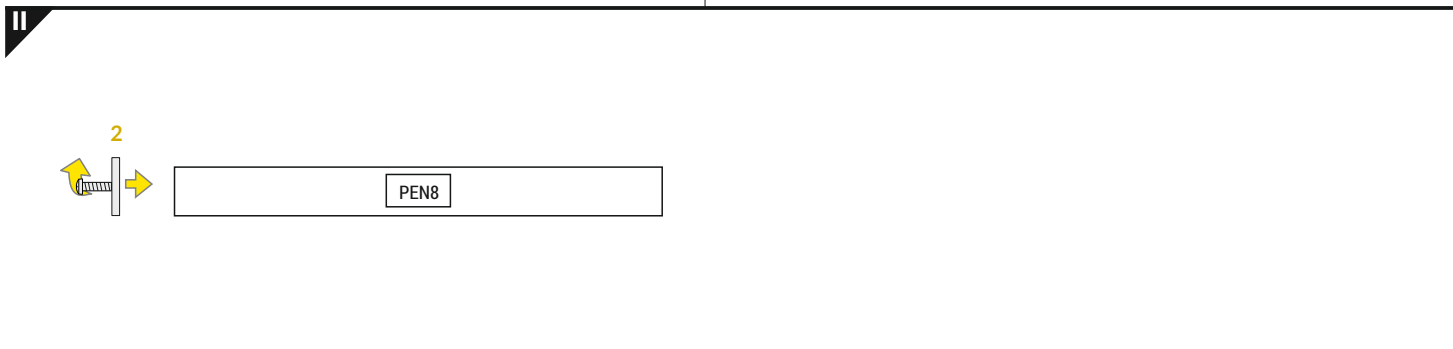
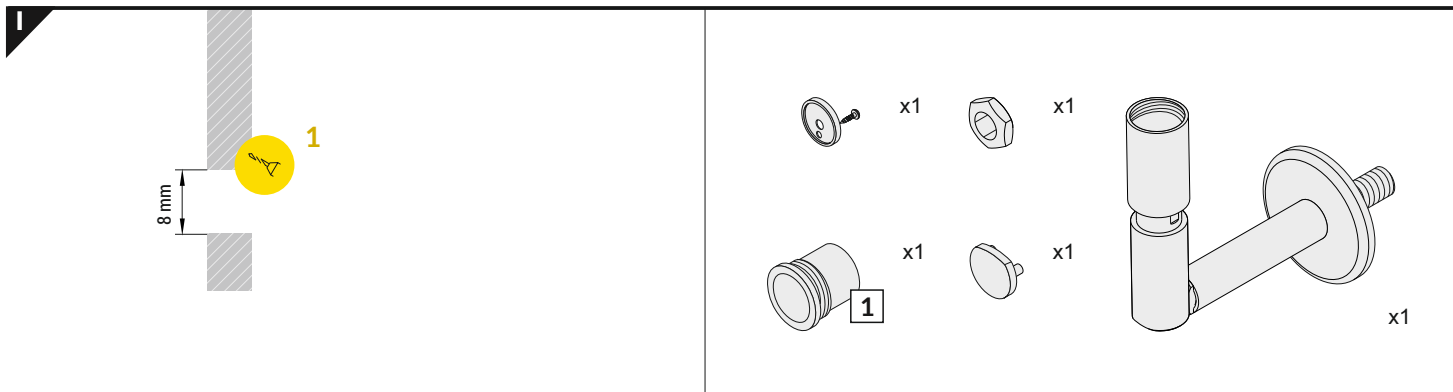

držák PEN8 kloubový na hmoždinky / PEN8 jointed holder with ceiling

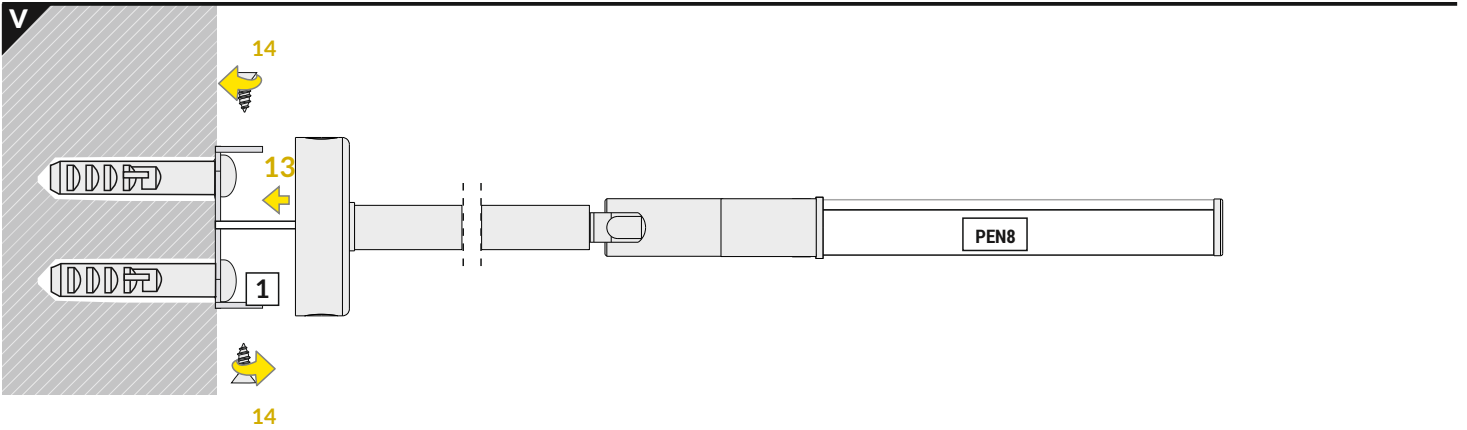
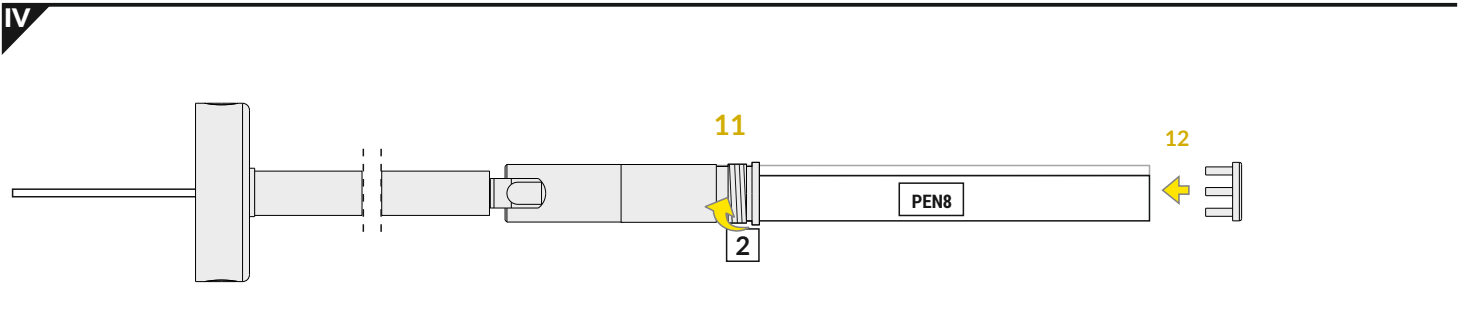
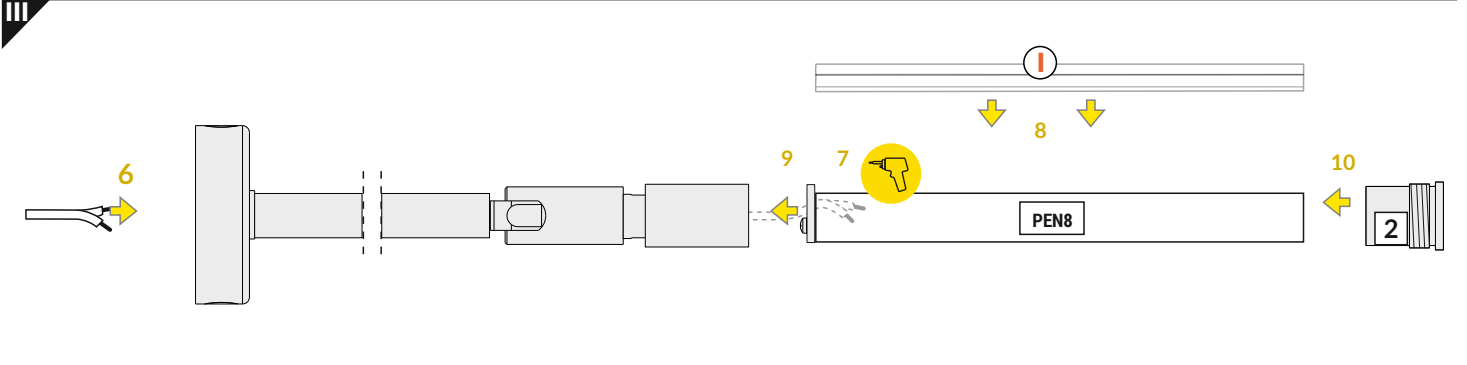
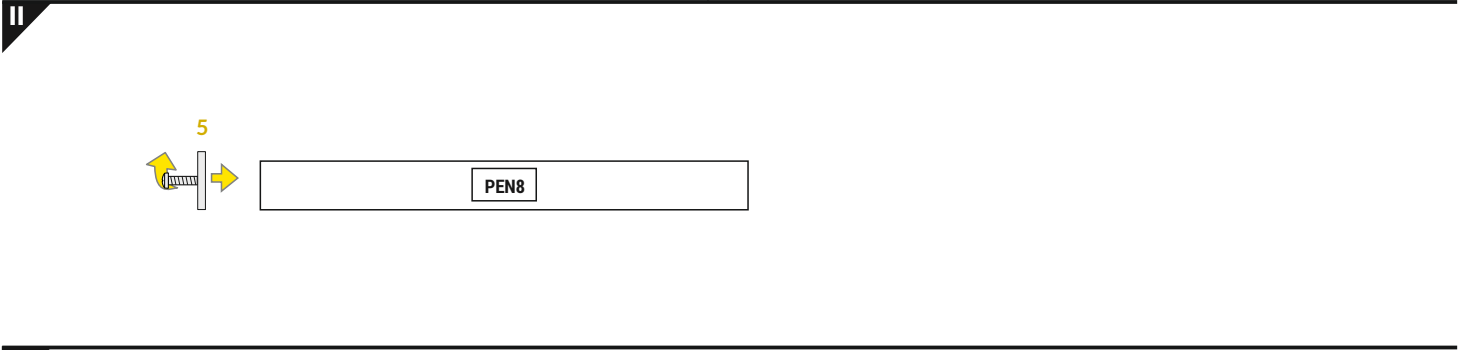
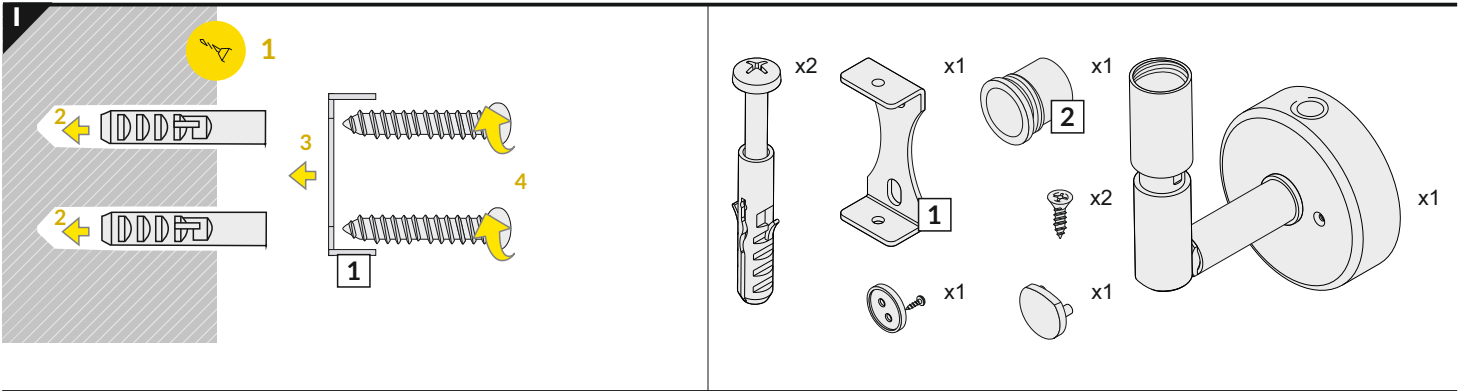

držák PEN8 dvojitý se závitem / PEN8 double holder with thread

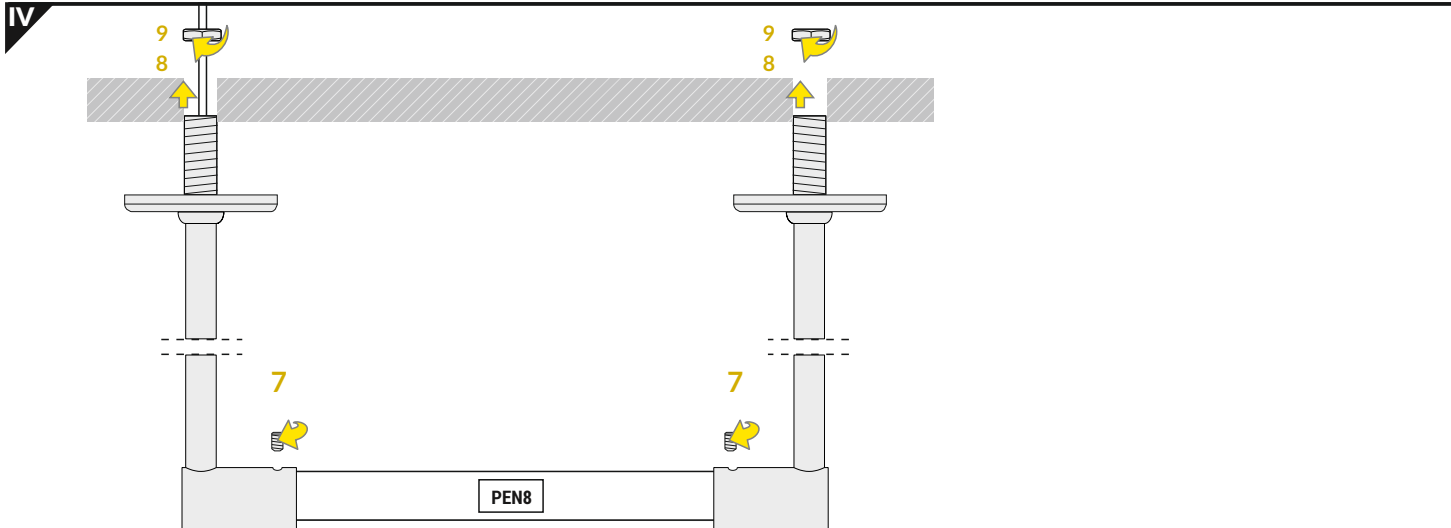
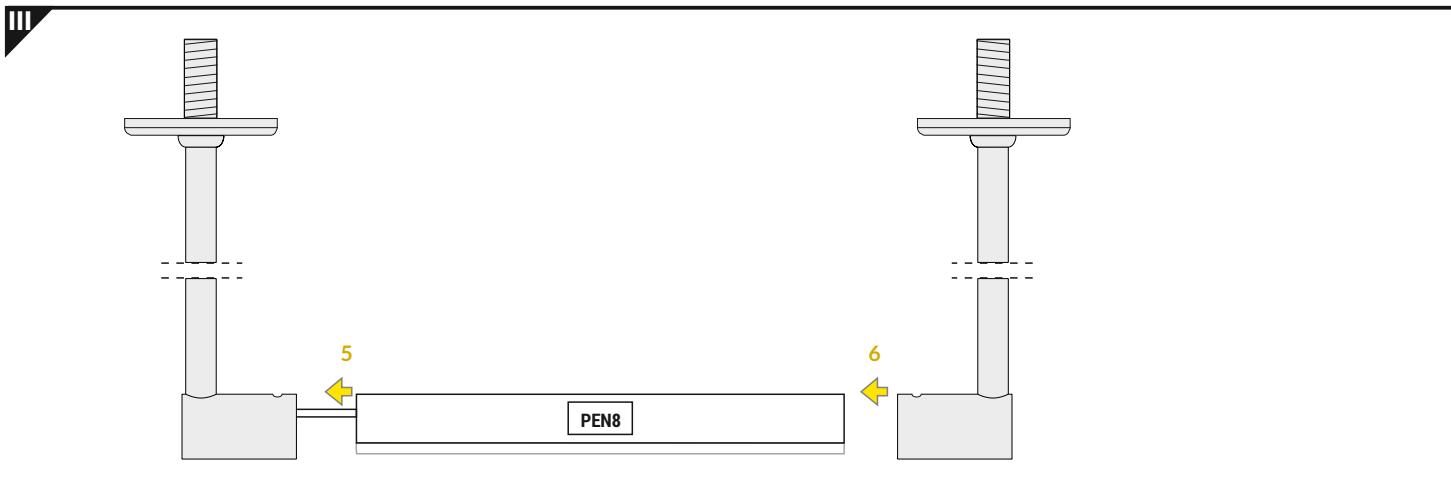
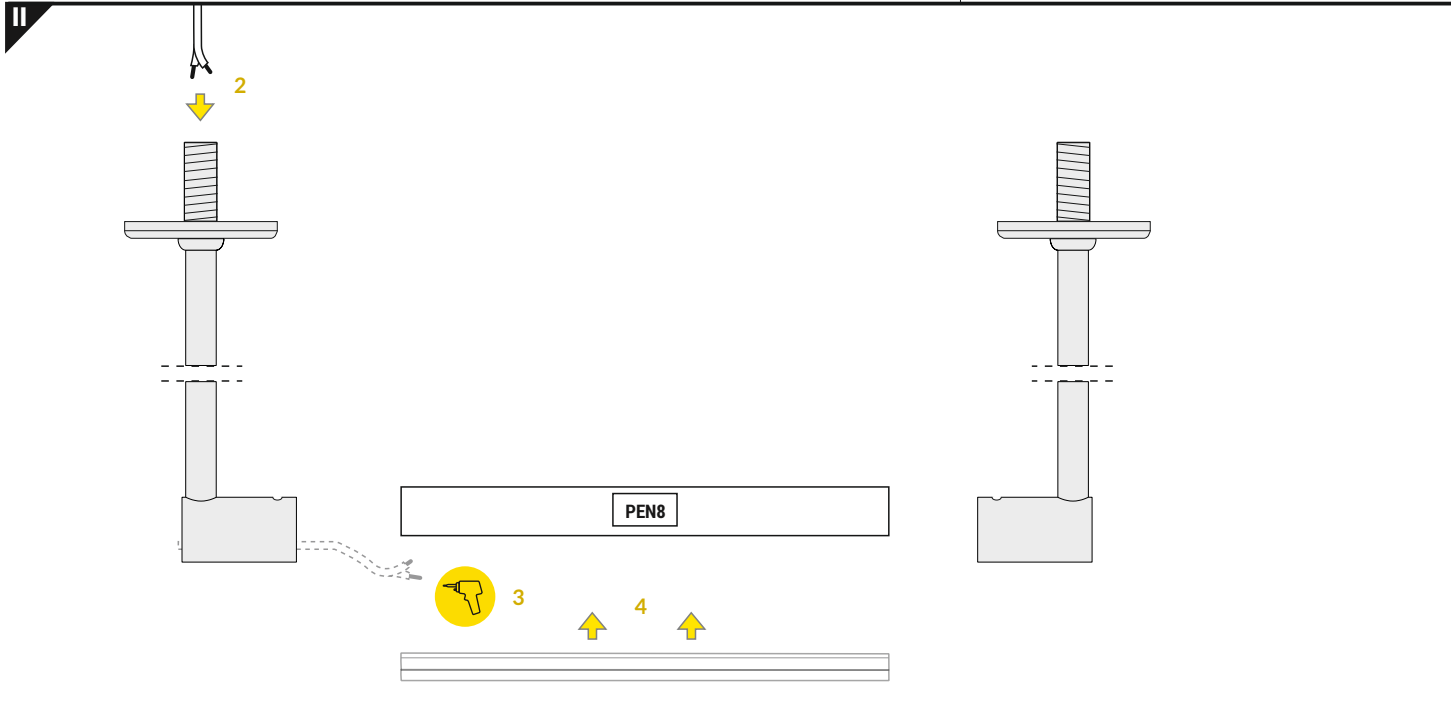
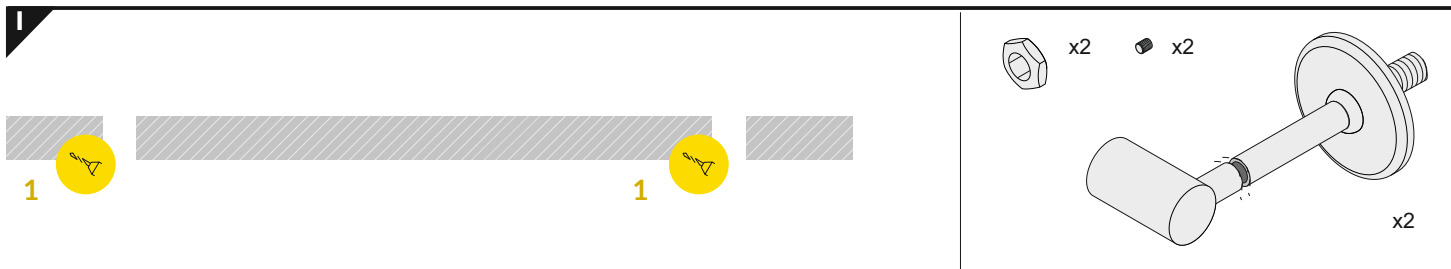

držák PEN8 dvojitý na hmoždinky / PEN8 double holder with ceilings

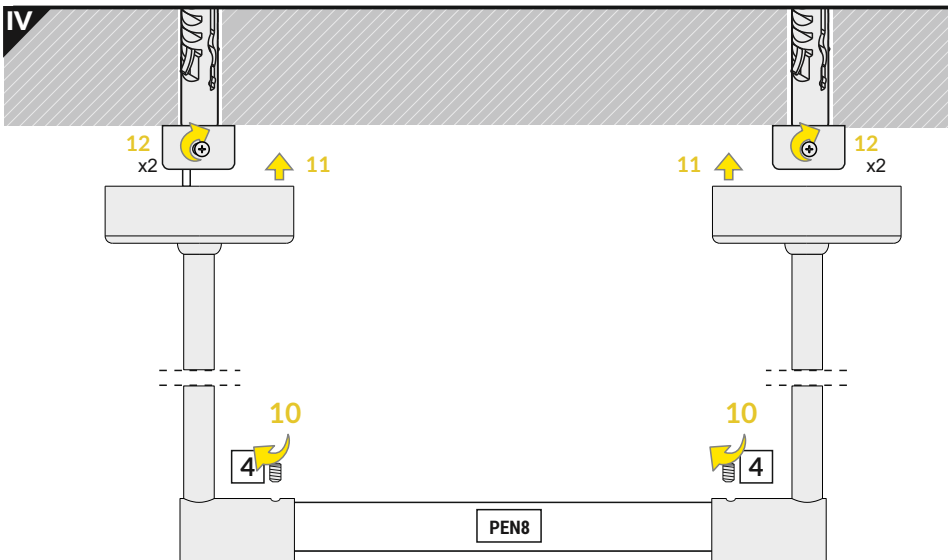
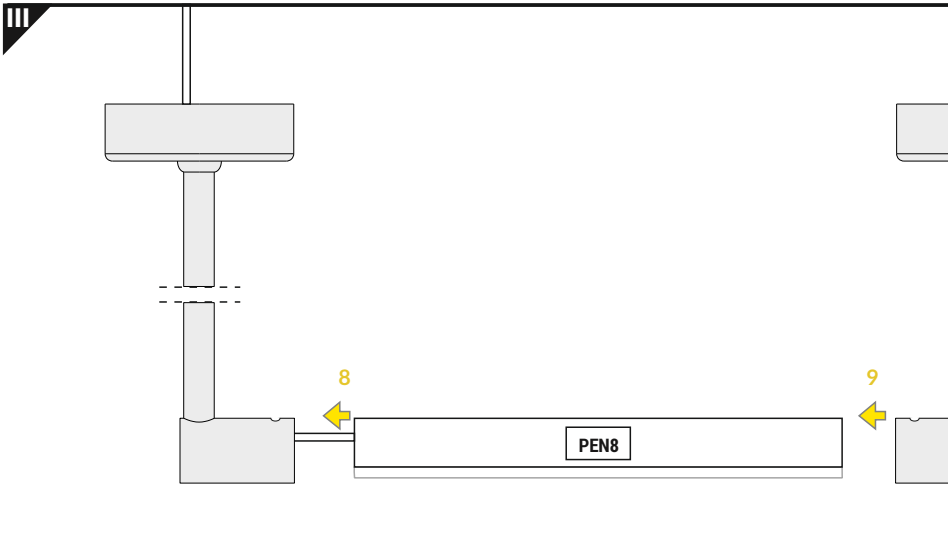
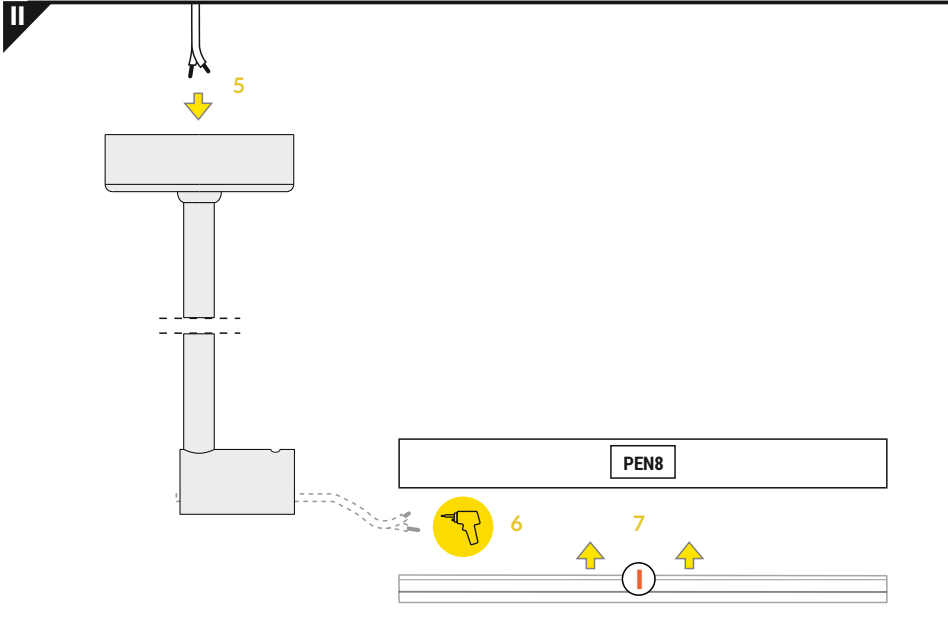
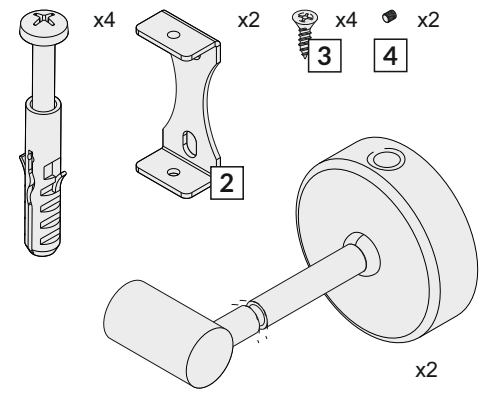
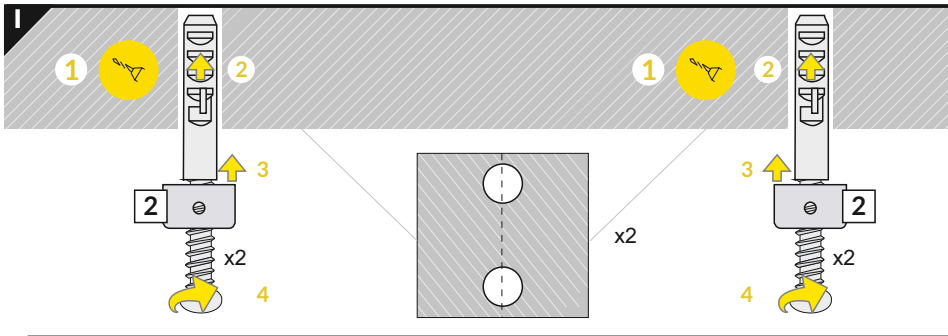

## držák PEN8 koncový jednostranný / PEN8 end holder

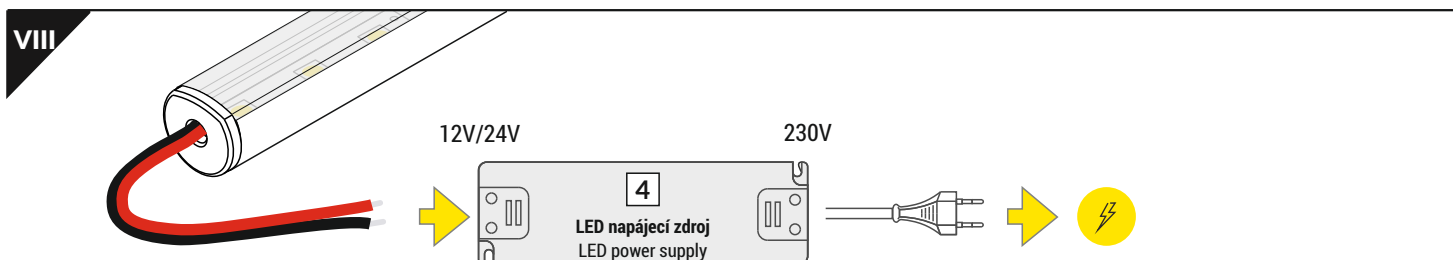
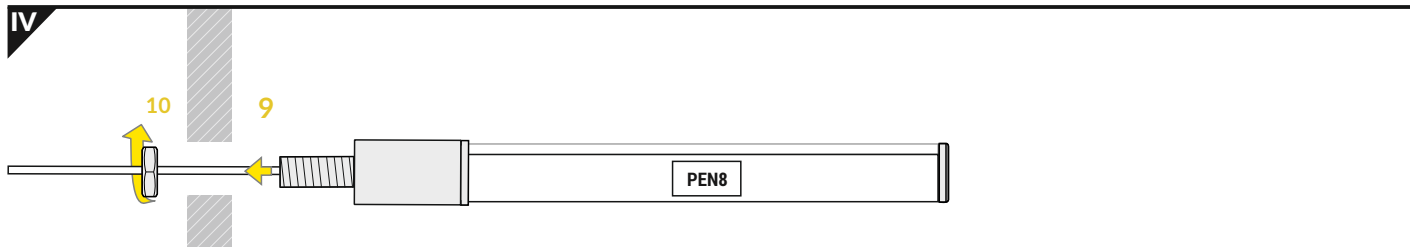
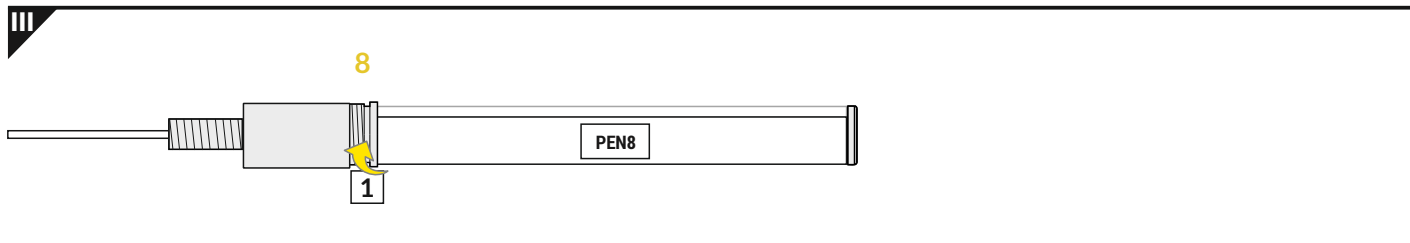
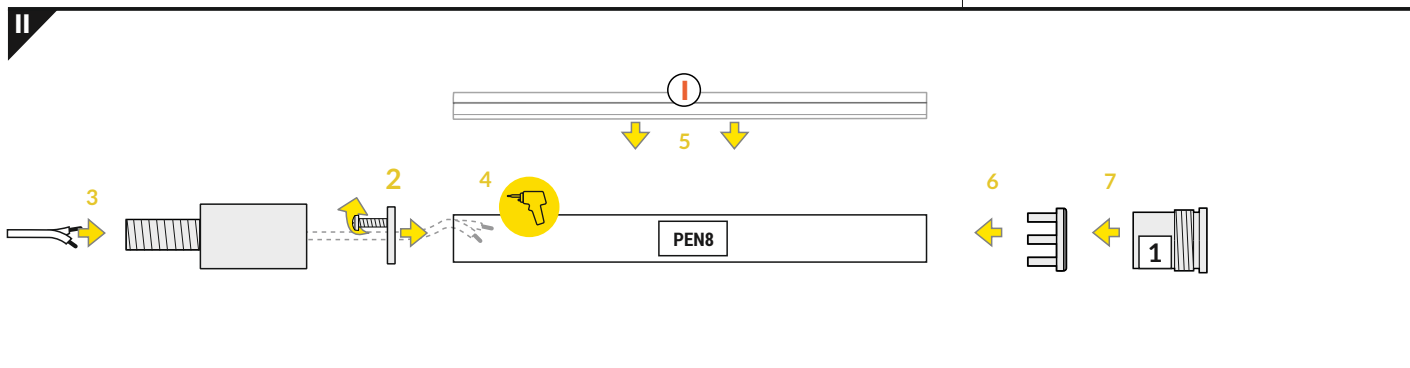

## PŘÍSLUŠENSTVÍ / ACCESSORIES

- spínače
- stmívače + ovladače
- pohybové senzory
- power switches
- controller + remote
- movement sensors

Zjistí více - [www.tron.cz](http://www.tron.cz) - TRON katalog LED profilů  
Check the rest - [www.tron.cz](http://www.tron.cz) - TRON LED profiles catalogue



TRON elektronické součástky, s.r.o.  
[www.tron.cz](http://www.tron.cz)