

CABI12 E

ÚHLOVÝ PROFIL / CORNER PROFILE

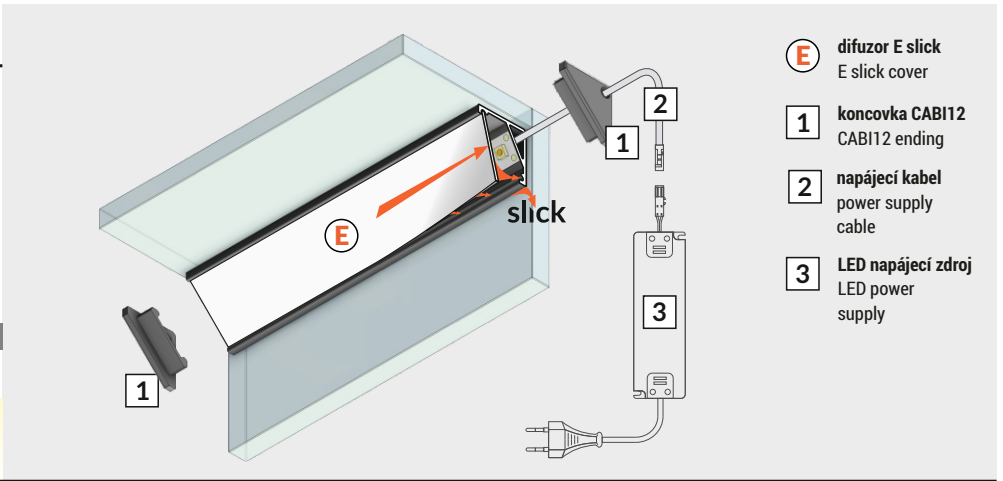
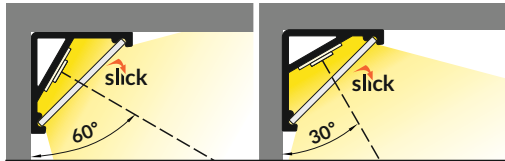
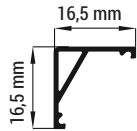

E difuzor E slick
E slick cover

1 koncovka CABI12
CABI12 ending

2 napájecí kabel
power supply
cable

3 LED napájecí zdroj
LED power
supply



nůžky
scissors



kleště
pliers



páječka
soldering iron



pájka
solder



lepidlo
glue

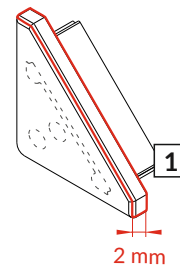
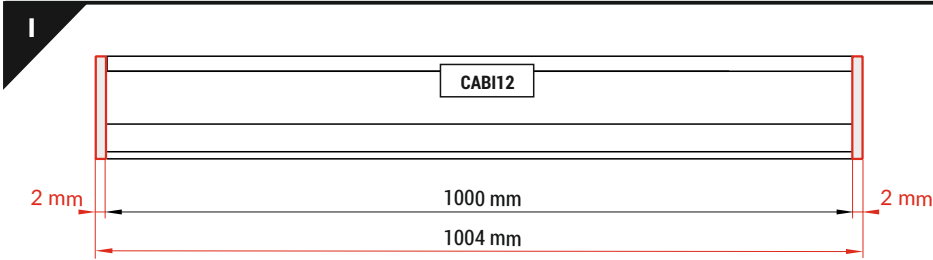

Pozor! Koncovka s označenými místy pro vrtání otvorů.
Note! Endings with marked space to bore a hole.

Pozor! S koncovkami se svítidlo prodlouží o 2 mm na každé straně.
Note! Ending thickness increases the length of the luminaire by 2 mm each side.

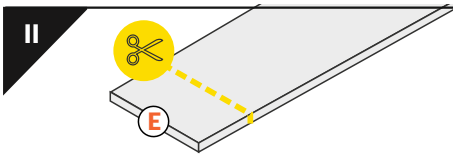

Délka difuzoru se rovná délce profilu.
The length of the cover is equal to the length of the profile.

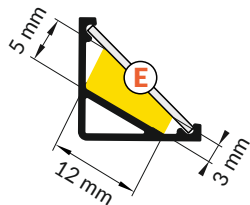
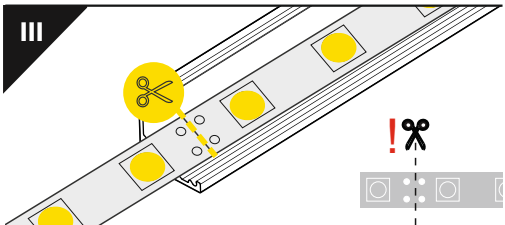

Ověř rozměry prostoru pro LED pásek.
Dimensions of the space to install LED source.

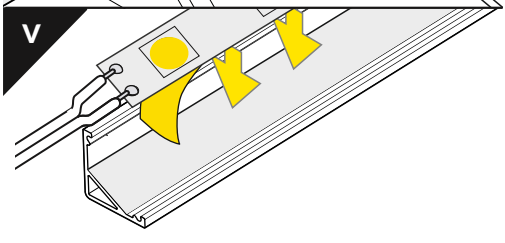
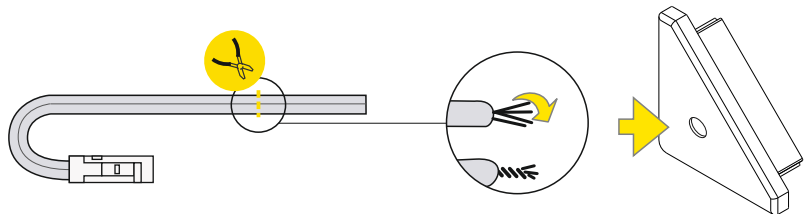
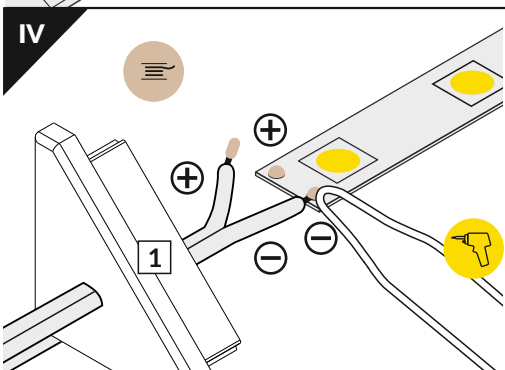

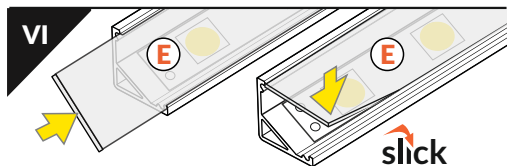

difuzor E slick / E slick cover

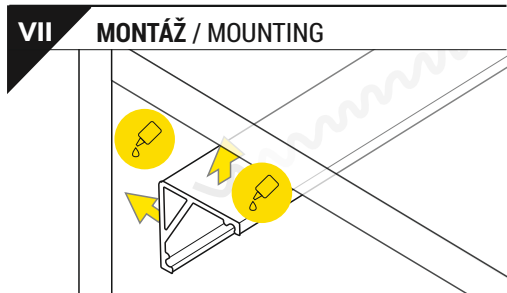

lepidlo
glue

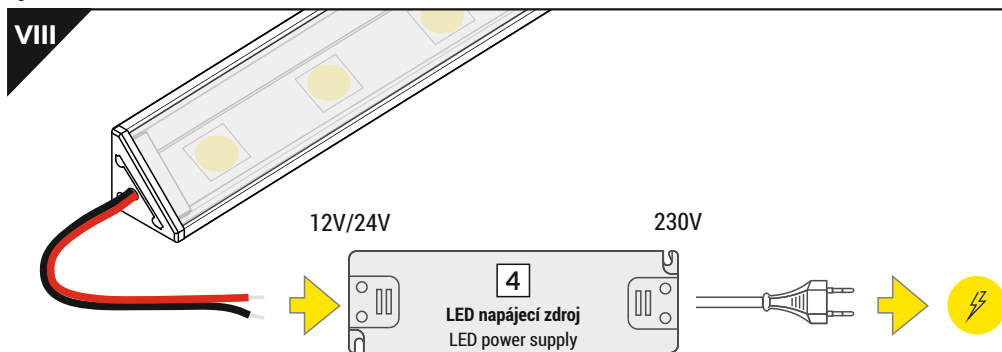

PŘÍSLUŠENSTVÍ / ACCESSORIES

- spínače
- stmívače + ovladače
- pohybové senzory
- power switches
- controller + remote
- movement sensors

Zjistí více - www.tron.cz - TRON katalog LED profilů

Check the rest - www.tron.cz - TRON LED profiles catalogue



TRON elektronické součástky, s.r.o.

www.tron.cz